

J-TOW390-TB

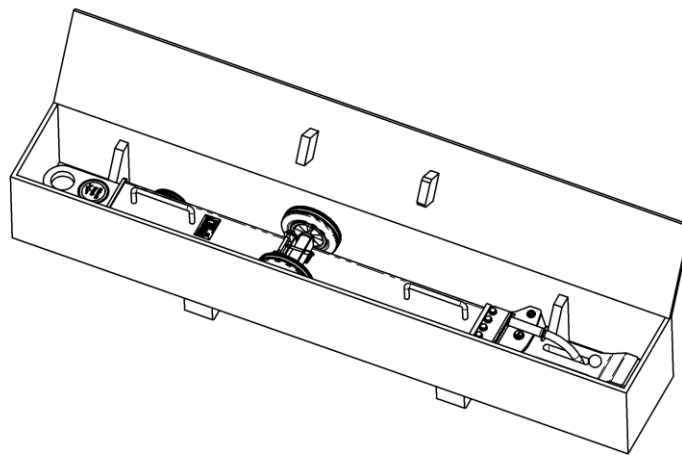
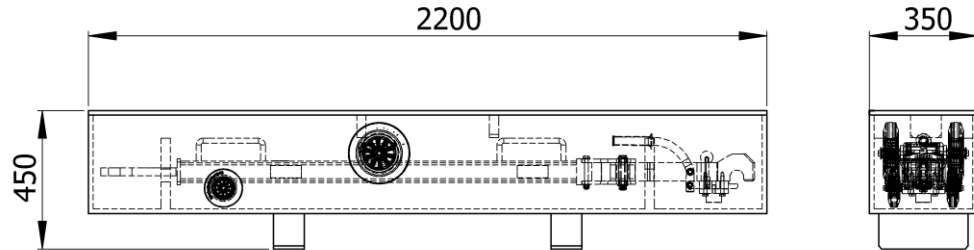

Standard features:

- Multiplex panel V100
- Standard color light grey RAL 7035
- Support blocks for the towbar
- Forklift trays

Options (at extra charges):

- Customized color i.a.w. RAL coding

Net weight:

- 25 kg / 55 lbs

Shipping dimensions incl. packaging:

Approx. Weight	Approx. shipping Dims l x w x h	Approx. Volume
[kg] 50	[mm] 2250 x 400 x 600	[m ³] 0,54
[lbs] 110	[inch] 88.5 x 15.7 x 23.6	[ft ³] 19